

deckvestTM

150N Automatic Lifejacket with integral Deck Harness

approved to CE European & ISO International Standards



- Includes essential Sprayhood, Thigh straps, Emergency line cutter, and Water-activated high intensity flashing Light

- **Unrestricted working at speed**

Soft contoured to fit the body, the clean, cutaway shape is strikingly comfortable to wear in all weathers.

- **Automatic inflation**

Latest UML Pro Sensor[®] automatic firing head designed to inflate when submerged. Visual indicator shows the 'armed' status of the cylinder and the firing head.

- **Instantly fitted**

The high tensile 2T front fastener provides instant access. Twin adjuster buckles ensure a snug and secure fit when tightened.

ESSENTIAL INFORMATION: DO NOT REMOVE UNTIL SOLD.

It is essential you read these instructions before using your Deckvest.

WARNING:

WHEN NOT CORRECTLY FITTED, THIS PRODUCT MAY NOT PERFORM AS A LIFEJACKET OR HARNESS RISKING SERIOUS DANGER TO THE USER.

For users aged above 16 years and weighing not less than 50 kg.

Do not use for white water paddling or with personal watercraft.

Do not use as a cushion.

Gas cylinders are dangerous goods. They should be kept out of reach of children and not be misused.



ISO 12402-3 - 150N Lifejacket

ISO 12401 - Deck Harness



50kg+



DECKVEST AUTOMATIC GAS INFLATION

This device is designed to inflate automatically upon immersion. Pulling the manual inflation handle will also activate the inflation mechanism or it can be inflated by blowing into the oral inflation tube. It can be converted to non-automatic operation using a Spinlock Deckware Series Manual Conversion Kit.

deckvestTM

www.spinlock.co.uk

Product features

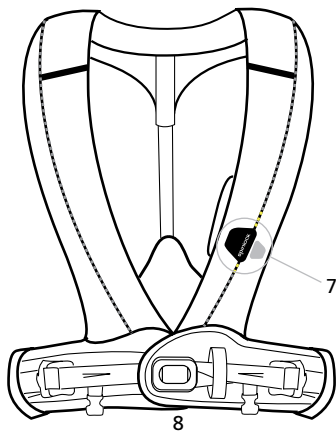

Inflated:

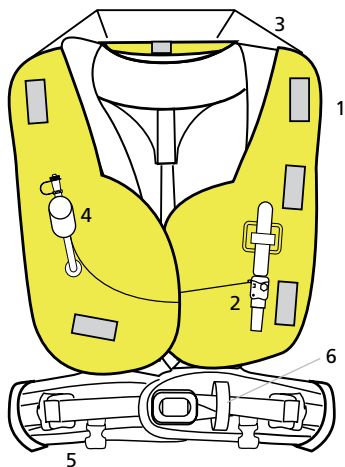

Ultra-compact personal deck safety wear.

deckvestTM features

1. Automatic Lifejacket (150N) with integral Deck harness.
2. Automatic inflation - Latest UML Pro Sensor[®] automatic firing head designed to activate when submerged.
3. Spray hood, to prevent inhalation of sea water. Easily accessible and structured to stand free of the face.
4. Visual indicator shows the 'armed' status of the cylinder and the firing head.
5. High intensity flashing light - activates upon contact with water.
6. Contoured thigh straps - shaped for maximum comfort to hold the jacket in position.
7. Safety line attachment loop. High tensile fibre - lighter, quieter and stronger than steel.
8. QBZ split zip. Instant access to oral inflator tube. Ensures rapid inflation and easy repacking.
9. Emergency safety line cutter. Stowed in snag-free pouch for instant access.
10. 'Through Life Support Program' for registered owners including extended 5 year guarantee.

Please register within 30 days of purchase at
www.spinlock.co.uk

Fitting and adjusting

A B C D E

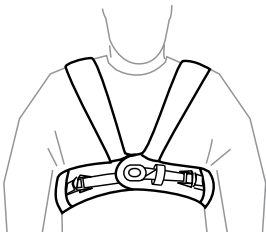
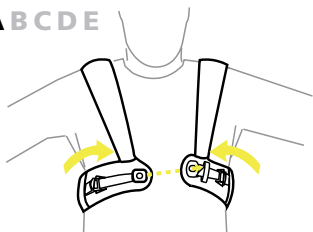

A B C D E

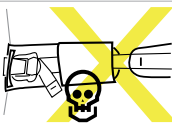
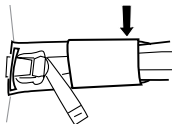
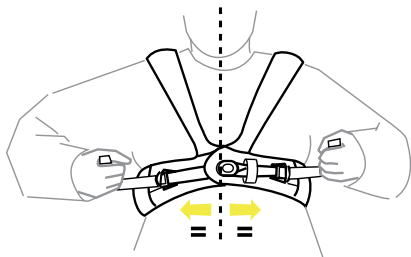
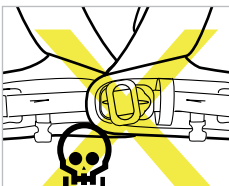
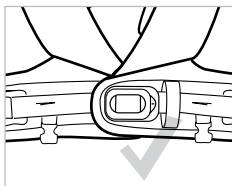

A B C D E

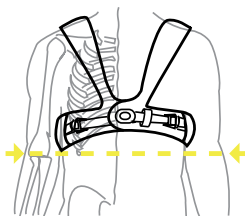
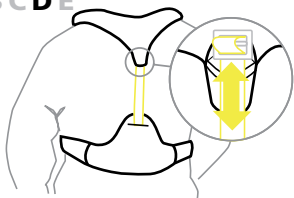

Tightening / loosening

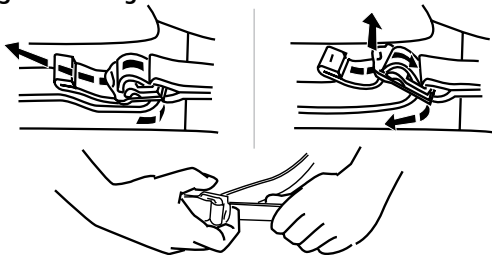

Threading buckles

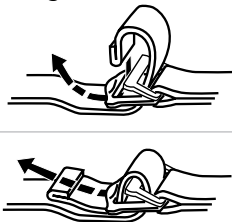

ABCDE

Fitting thigh straps

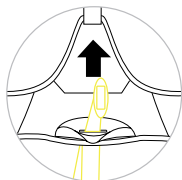

Back of harness

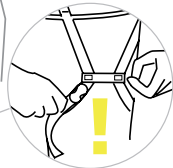
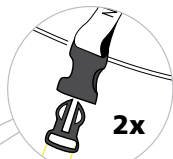

How to use

Safety line attachment point - Only use marked loop for attachment.

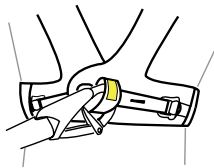
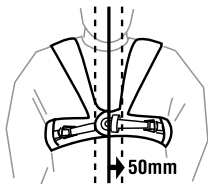

Guidance

Jackstays / Fixed eyes

Anchorage points must be able to withstand forces more than 1 tonne.

(Safety line for illustration only)

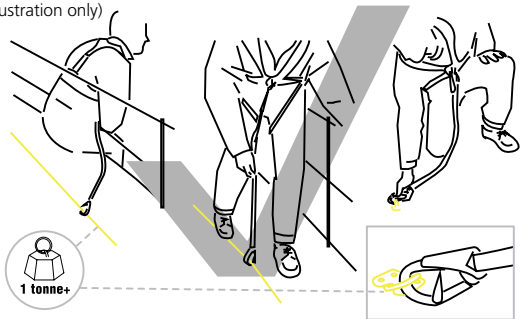

Lifejacket inflation: UML Pro Sensor®

Manual / Auto

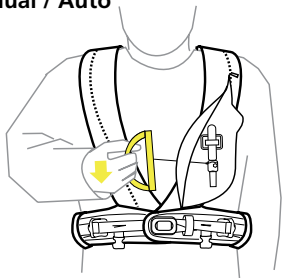

Auto

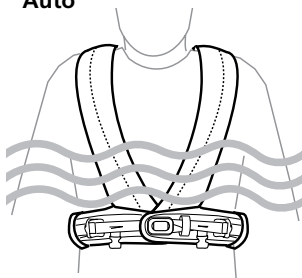

Oral inflation

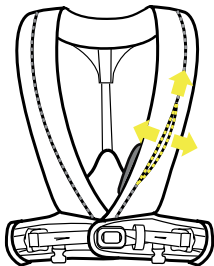

A B

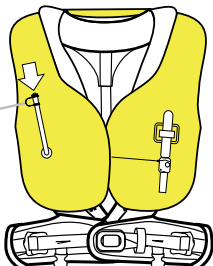
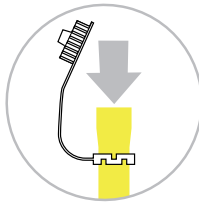

A B

Firing head

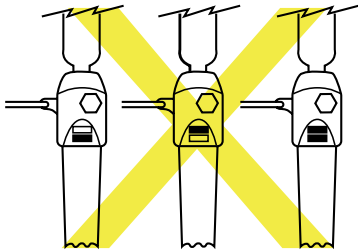
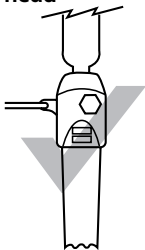

Green Red

1. A B C D

Remove all air.

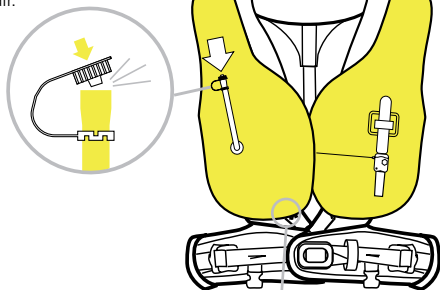

A B C D

Open zips.

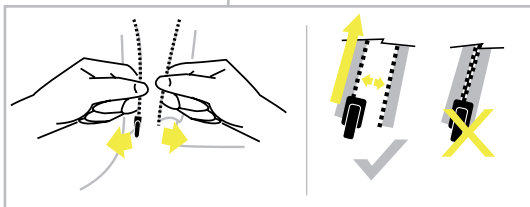

A B C D

Run right hand slider round to left hand side.

A B C D

RE-attach zips on side with Firing head.

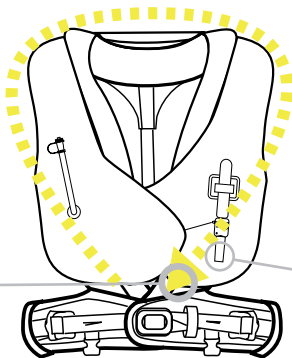

Insert firing-head into mesh pocket on the cover.

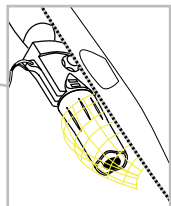
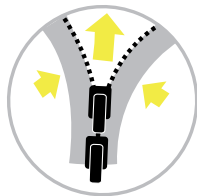

2. Concertina bladder onto itself ensuring a smooth flow for the manual lanyard.

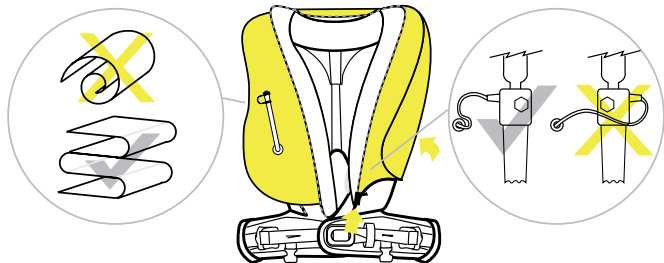

3. Concertina top in.

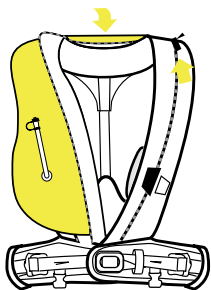

4. Run zip round to close and fasten flap across breakout point and ensure firing head is aligned in the window

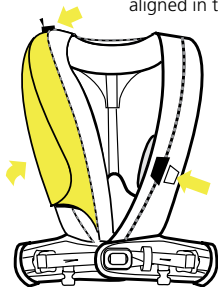

Sprayhood

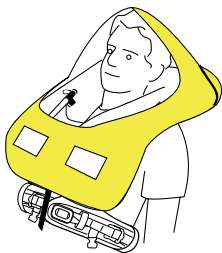

Contents

	Page no:
Introduction	9
Approval conditions	9
Inflating and deflating your lifejacket	10
Maintaining your Deckvest	11
Testing your lifejacket	12
Re-arming and re-packing your lifejacket	13-14
Instructions for use	15-17
Inspection record sheet	18

Spinlock Deckvest

This Deckvest is an integrated lifejacket and harness approved to **ISO 12402-3** (150N). It is important to get into the habit of wearing Deckvest. It is comfortable, safe and a pleasure to wear.

A lifejacket or harness only works if it is fitted and secured correctly.

Inflatable lifejackets only become buoyant when inflated: they contain no inherently buoyant materials.

As user, it is your personal responsibility to understand the operation and maintenance requirements of your inflatable lifejacket and be familiar with its limitations.

Approval conditions:

This Deckvest is an integrated CE approved lifejacket according to **ISO 12402-3** (150N) and a CE approved Deck harness according to **ISO 12401**.

Inflating your lifejacket

It is recommended that the following inflation procedures are followed:

1. MANUAL INFLATION

To manually inflate the lifejacket, sharply pull the rubber handle downwards. The CO₂ gas cylinder should inflate the bladder within seconds.

2. ORAL INFLATION

To inflate the lifejacket by mouth, locate the oral inflation tube by opening the zip at the yellow breakout point on the front panel of the lifejacket. Then after removing the end cap, blow into the tube until the lifejacket is fully inflated.

3. AUTOMATIC INFLATION

Inflation should occur automatically within seconds of the inflator being submerged. The automatic capsule is designed to activate the sprung pin to puncture the CO₂ cylinder and inflate the bladder.

CO₂ Cylinder size

Model 150N: use 33g

INFORMATION: PRESSURE VARIANCE

With variations in air or water temperatures, topping up by oral inflation may be required to maintain full buoyancy-especially after prolonged immersion.

Deflating the lifejacket

To deflate the lifejacket, invert the oral-inflation tube end cap and insert it into the valve. Holding the cap firmly in this position, gently squeeze the lifejacket until all air or gas has been expelled. Return the cap to its normal position.

Usage below freezing

When the temperature is below freezing, even a fully charged cylinder may not adequately inflate your lifejacket. Do not use your lifejacket under these conditions unless it has been partially inflated by mouth.

WARNING: Using the CO₂ inflation when your jacket is already fully inflated can over-pressurise and damage your lifejacket.

Maintaining your Deckvest

Maintaining this Deckvest should be the responsibility of one sole user. As the user you are strongly advised to familiarise yourself fully with the Deckvest before using it as a lifejacket.

We advise that you follow a 3-level checking routine, easily carried out by yourself:

1. **During Use**, check buckles and other fastenings regularly.
2. **Before and after use**, examine for damage or excessive abrasion, wear, tear or contamination. Particular attention must be paid to the stitching and webbing, including the less accessible areas.
3. **Every three months**, carry out a complete inspection, checking:

- a. **The fabric:** for cuts, tears, abrasion and damage caused by heat, chemicals etc.

- b. **The lifejacket:** to check for leaks inflate your lifejacket through the oral tube until firm and leave for 24hrs. Any loss of firmness indicates leakage and means it is unsafe.

To check the oral valve, fully inflate the lifejacket and hold the tube under water. If bubbles appear, deflate and re-inflate to test.

If a leak persists, do not use your lifejacket until it has been professionally serviced at your nearest service centre.

- c. **The components:** removing and inspecting all components as detailed in the section 'Re-arming your lifejacket' page 13.

WARNING:

If in doubt, send your Deckvest to your nearest service centre for evaluation and/or servicing.

If you are not completely confident about undertaking the self-inspection and servicing of your lifejacket in accordance with these instructions, you must not use your lifejacket again until it has been professionally inspected and serviced. (For details of your nearest service centre see www.spinlock.co.uk).

Any modification or repair to any part of the Deckvest is expressly forbidden unless carried out by Spinlock Ltd.

Testing your lifejacket

You should always test the inflation of your lifejacket to ensure you are fully aware of how it functions.

This can be done with the Oral, Manual or Automatic inflators.

If planning to test the lifejacket with the Oral inflator you will not need any spare parts or rearming kits as long as you remove the CO2 cylinder and automatic capsule before entering the water.

If you are a weak swimmer it is strongly recommended to use an automatic lifejacket or an inherently buoyant device.

1. Put on the Deckvest and adjust to fit.
2. Stand in shallow water or swimming pool, just deep enough for your head to be above the surface.

3. Inflation:

Automatic: lifejacket should fully inflate within five seconds of water contacting the firing head.

Manual: lifejacket can be activated by a sharp pull on the inflation handle.

Oral inflation: Ensure that cylinder and firing head have been removed before entering the water. Open the lifejacket cover from the zip breakout point, locate the oral inflator, remove cap and blow through tube.

4. After testing completely deflate the lifejacket using the oral inflator.
5. Let the Deckvest dry thoroughly. Do not expose to direct heat.

REMEMBER: RE-ARM AND RE-PACK THE LIFEJACKET IN ACCORDANCE WITH THESE INSTRUCTIONS - See video at www.spinlock.co.uk

WE RECOMMEND THAT THE AUTOMATIC CAPSULE IS REPLACED ANNUALLY. ALSO UNSCREW AND INSPECT THE THREADED END OF THE CO2 CYLINDER TO CONFIRM IT IS UNUSED. (SEE FIG 1, PAGE 13)

Re-arming and re-packing your lifejacket after inflation

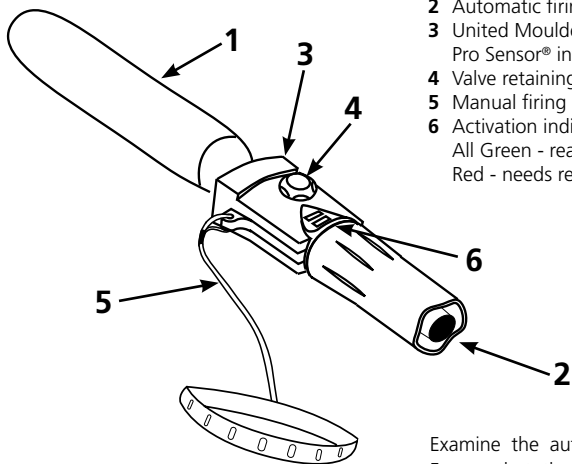

- 1 33 g CO2 cylinder
- 2 Automatic firing capsule
- 3 United Moulders Pro Sensor® inflator
- 4 Valve retaining nut
- 5 Manual firing lanyard
- 6 Activation indicator window
All Green - ready to go
Red - needs rearming

Examine the automatic capsule. Ensure that the cap is screwed hand tight onto the inflator.

Check the components and assemble the inflator following these steps:

1. Unscrew and remove the 33g CO2 gas cylinder from the inflator and inspect its piercing cap. If it has been pierced, replace it! (Fig.1).

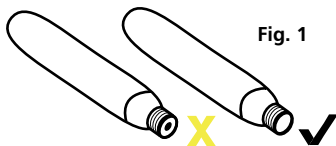
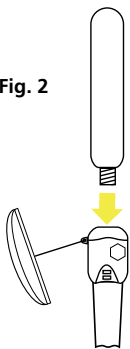

Fig. 1

Fig. 2



2. Make sure the manual lever is in the up and ready position. Install the CO2 cylinder into the inflator by screwing it until hand-tight (Fig.2). Check that the automatic capsule has not been fired by ensuring that the bottom indicator is showing green.

3. Check that the oral-inflation tube cap is in stowed position B (Fig.3).

A Dust cap in deflate position

B Dust cap in stowed position

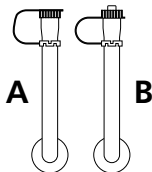
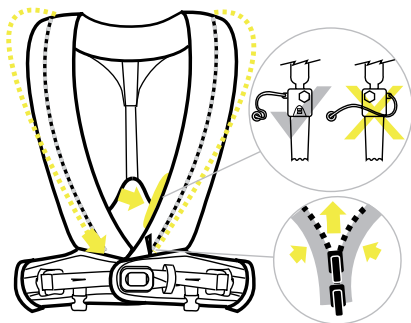

Fig. 3

Fig. 4



4. Ensure the cord runs freely from the firing head to the eyelet in the cover. Re-fasten the zipper. If everything conforms to the preceding instructions, your lifejacket is ready for use. Re-run the zip back around the cover to close (Fig.4).

Safety Notices

FITTING ADJUSTMENTS (PAGES 3 & 4)

A. Put on as jacket, B. Fasten Button, C. Pull chest belt tight – it is unsafe to wear any lifejacket or harness loosely. D. Adjust back strap so that chest belt is positioned above lowest point of rib cage. E. Attach thigh straps - passing thigh strap through legs before fastening plastic buckle on front.

HOW TO USE (PAGES 5 & 6)

A. Anchorage point should be located at the centre of the chest. Note: safety line is for illustration only. Ensure no sharp edges on safety line attachment point. Use with an approved personal safety line only. Attach to Jack line / fixed eyes. Anchorage points must be able to withstand forces of more than 1 tonne. Never attach to lifelines / standing or running rigging.

GENERAL INFORMATION

Important notice: Specific training is essential before use

Read this notice carefully before use. This technical notice illustrates ways of using this product. Only some types of misuse and forbidden uses currently known are represented (shown in crossed out diagrams). Many other types of misuse exist which are impossible to list or even imagine. Only the techniques shown in the diagrams and not crossed out are authorised. All other uses are expressly excluded; danger of death. In case of doubt or any problem of understanding, contact Spinlock. Water sports are dangerous activities which may lead to severe injuries or even death. Adequate training in appropriate safety techniques and methods is essential and acquiring this training is your own responsibility. You personally assume all risks and responsibilities for all damage, injury or death which may occur during or following wrong use of our products in any manner whatsoever. If you are not able, or are not in a position to assume this responsibility or to take such risks do not use this equipment.

USE

This product must only be used by competent and responsible persons, or those placed under the direct and visual control of a competent and responsible person. Check that this product is compatible with other components of your equipment. To prolong the life of this product, care in use is necessary. Avoid rubbing against abrasive surfaces or sharp edges.

A deck harness and safety line are intended to prevent the user falling overboard: they do not provide protection against falls from height. In a fall the deck safety harness and safety line may transmit very large forces to the anchorage point.

Full performance may not be achieved if using watertight/waterproof clothing or in other circumstances. Gas cylinders are dangerous goods and should be kept away from children and not misused. Do not use as a cushion. Train yourself in the use of this device.

WARNING: WHEN NOT CORRECTLY FITTED, THIS DECKVEST MAY NOT PERFORM AS A LIFEJACKET OR HARNESS AND MAY ENDANGER THE USER.

MAJOR FALLS

In the event that your full body weight is dropped a distance and then stopped, do not continue to use this product. Even if no external changes are visible, internal damage may have reduced its strength and its margin of safety. Do not hesitate to contact Spinlock in case of doubt.

CLEANING, MAINTENANCE, STORAGE

Remove gas cylinder and automatic components and then clean by hand and rinse in clean fresh water (maximum temperature 30° C). Dry in a cool, ventilated dark room. Grease spots may be removed with trichlorethylene. Webbing shrinks very slightly in drying. Always carry and store your Deckvest in a well ventilated bag. Though UV protected, this product is best stored away from direct light, in a well ventilated place away from extreme temperatures.

CHEMICALS

All chemicals, (including petrol, battery acid), corrosive materials and solvents should be regarded as harmful. If your Deckvest comes in contact with chemicals, please notify Spinlock, stating the precise chemicals concerned. We will investigate and give our advice.

LIFETIME = SHELF LIFE + USEFUL LIFE

After first use this product should last 5 years. Certain environmental elements will considerably accelerate wear: salt, sand and chemicals. In exceptional circumstances, wear or damage could occur on the first use which reduces the lifetime of the product to that one, single use. However wear or damage can shorten the product life. Shelf-life of this product in good condition is up to 5 years before first use.

TEMPERATURE

Use this product only above a minimum of -30° C and below a maximum of +60° C.

DISINFECTING THE PRODUCT

When necessary, use a disinfectant that is compatible with polyamide, polyester, polycarbonate, PVC etc. Use diluted with clean water at a maximum temperature of 30° C. After soaking for an hour, rinse in clean cold water. Dry slowly, away from direct heat.

RESPONSIBILITY

Spinlock is not responsible for the consequences, direct, indirect or accidental, or any type of damage befalling or resulting from the use of its products.

GUARANTEE

This product is guaranteed against any faults in materials or manufacture for two years from the date of manufacture. This guarantee is extended to five years conditional on registration of ownership by the first owner. Exclusions from the guarantee include: normal wear and tear, modifications or alterations, incorrect storage, damage due to accident, negligence and any use for which the product was not designed.

Certain environmental elements will considerably accelerate wear: salt, sand, moisture, chemicals. In exceptional circumstances, wear or damage could occur on the first use which reduces the lifetime of the product to that one single use. See www.spinlock.co.uk for full details.

(EN) Temperature
 (FR) Température
 (DE) Temperatur
 (IT) Temperatura
 (ES) Temperatura
 (NL) Temperatuur
 (DK) Temperatur
 (S) Temperatur

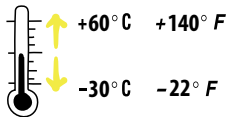
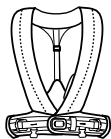

(EN) Storage
 (FR) Stockage
 (DE) Lagerung
 (IT) Conservazione
 (ES) Almacenamiento
 (NL) Berging
 (DK) Opbevaring
 (S) Förvaring

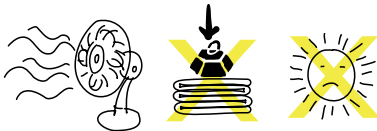

(EN) Dangerous products
 (FR) Produits dangereux
 (DE) Gefährliche Produkte
 (IT) Prodotti pericolosi

(ES) Productos peligrosos
 (NL) Gevaarlijke producten
 (DK) Farlige væsker
 (S) Farliga produkter

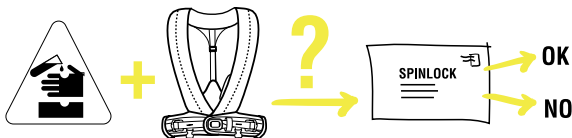

(EN) Cleaning / Disinfection
 (FR) Nettoyage / Désinfection
 (DE) Reinigung / Desinfektion
 (IT) Pulizia / Disinfezione

(ES) Limpieza / Desinfección
 (NL) Reiniging / Ontsmetting
 (DK) Rengøring / Decinficerer
 (S) Rengöring/ Desinfektion



(EN) Drying
 (FR) Séchage
 (DE) Trocknen
 (IT) Asciugamento

(ES) Secado
 (NL) Het drogen
 (DK) Tørrer
 (S) Torkning

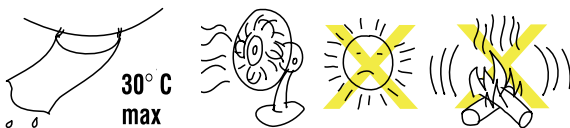

(EN) Model :

(F) Modèle :
 (D) Modell :
 (IT) Modello :
 (ES) Modelo :
 (NL) Model :
 (DK) Model :
 (S) Modell :

(EN) Purchase date :

(F) Date de l'achat :
 (D) Kaufdatum :
 (IT) Data di acquisto :
 (ES) Fecha de compra :
 (NL) Aankoop datum :
 (DK) Købs dato :
 (S) Köpdatum :

(EN) Batch n° :

(F) N° de série :
 (D) Seriennummer :
 (IT) N° di serie :
 (ES) N° de serie :
 (NL) Seriennummer :
 (DK) Seriennummer :
 (S) Seriennummer :

(EN) Date of first use :

(F) Date de la première utilisation :
 (D) Datum der ersten Verwendung :
 (IT) Data del primo utilizzo :
 (ES) Fecha de la primera utilización :
 (NL) Datum eerste gebruik :
 (DK) Dato for ibrugtagning :
 (S) Första användnings datum :

(EN) Year of manufacture :

(F) Année de fabrication :
 (D) Herstellungsjahr :
 (IT) Anno di fabbricazione :
 (ES) Año de fabricación :
 (NL) Productie jaar :
 (DK) Produceret år :
 (S) Produktions år :

(EN) User :

(F) Utilisateur :
 (D) Benutzer :
 (IT) Utilizzatore :
 (ES) Usuario :
 (NL) Gebruiker :
 (DK) Bruger :
 (S) Användare :

(EN) Comments :

(F) Commentaires : _____
 (D) Bemerkungen : _____
 (IT) Note : _____
 (ES) Comentarios : _____
 (NL) Aantekeningen : _____
 (DK) Bemærkninger : _____
 (S) Anteckningar : _____

(EN) Inspection every 3 months

(F) Inspection tous les 3 mois
 (D) Kontrolle alle 3 Monate
 (IT) Controllo ogni 3 mesi

(ES) Inspección cada 3 meses
 (NL) Inspectie iedere 3 maanden
 (DK) Inspektion hver 3 måned
 (S) Inspektion var tredje måned

(EN) DATE

(F) DATE _____
 (D) DATUM _____
 (IT) DATA _____
 (ES) FECHA _____
 (NL) DATUM _____
 (DK) DATO _____
 (S) DATUM _____

OK**INSPECTOR**

INSPECTEUR HABILITE _____
 KONTROLLBEAUFTRAGTER _____
 CONTROLORE _____
 INSPECTOR _____
 INSPECTEUR _____
 KONTROLLERET AF _____
 INSPEKTÖR _____

Deckvest Serial number



Useless unless worn

Spinlock supports the
Royal National Lifeboat Institution (RNLI)
'Sea Safety Lifejacket Campaign'

Please register your Deckvest serial number now at www.spinlock.co.uk

Spinlock Ltd
41 Birmingham Road
Cowes PO31 7BH
United Kingdom

The Spinlock Deckvest is extensively protected under various National, European and International Patents and Design Rights owned by Spinlock Ltd.

For continuously updated user guidance go to
www.spinlock.co.uk



3R425A_2